

250BZ622H -61
250BZ437H -61
250BZ445H -61

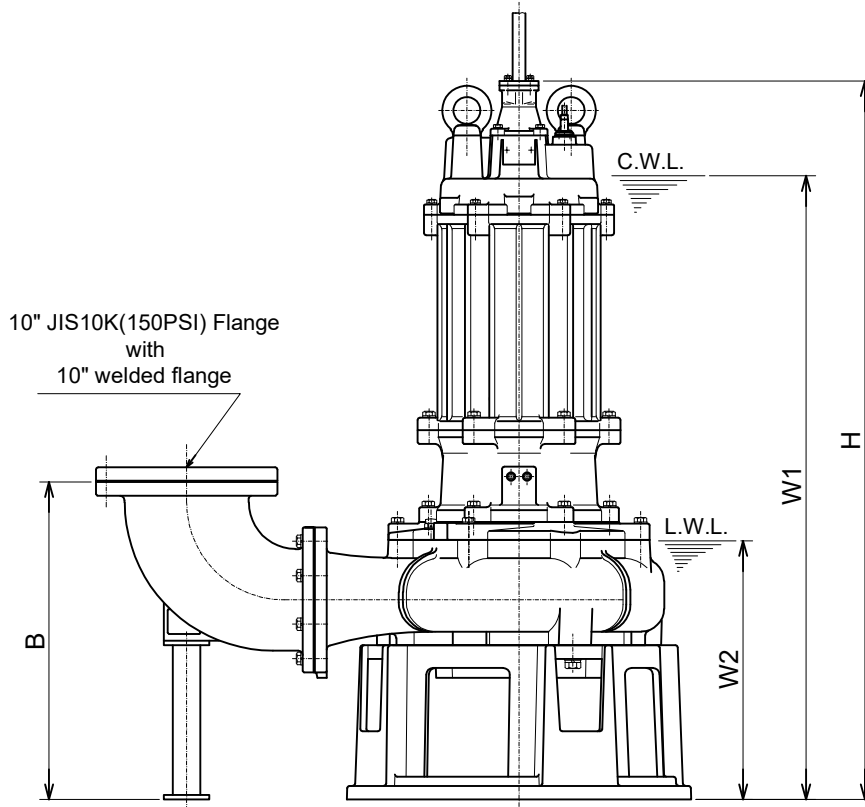

C.W.L. :Continuous running Water Level
L.W.L. :Lowest running Water Level

DIMENSIONS:USCS (Inch)

Model	HP	NOM. SIZE	Pump & Motor									C.W.L.	L.W.L.	*Wt. (lbs.)
			A	A1	A2	A3	B	D	D1	D2	H			
250BZ622H-61	30	10"	51 11/16	28 7/8	14 15/16	17 11/16	27 9/16	29 15/16	14 15/16	14 15/16	62 3/8	54 1/8	22 1/2	1680
250BZ437H-61	50	10"	51 11/16	28 7/8	14 15/16	17 11/16	27 9/16	29 15/16	14 15/16	14 15/16	61 7/8	53 3/4	22 1/2	1830
250BZ445H-61	60	10"	51 11/16	28 7/8	14 15/16	17 11/16	27 9/16	29 15/16	14 15/16	14 15/16	62 3/8	54 1/8	22 1/2	1850

DIMENSIONS:METRIC (mm)

*Excluding Cable

Model	kW	NOM. SIZE	Pump & Motor									C.W.L.	L.W.L.	*Wt. (kg)
			A	A1	A2	A3	B	D	D1	D2	H			
250BZ622H-61	22	250	1313	733	380	450	700	760	380	380	1584	1375	570	760
250BZ437H-61	37	250	1313	733	380	450	700	760	380	380	1572	1365	570	830
250BZ445H-61	45	250	1313	733	380	450	700	760	380	380	1584	1375	570	840