

KRS2-B6

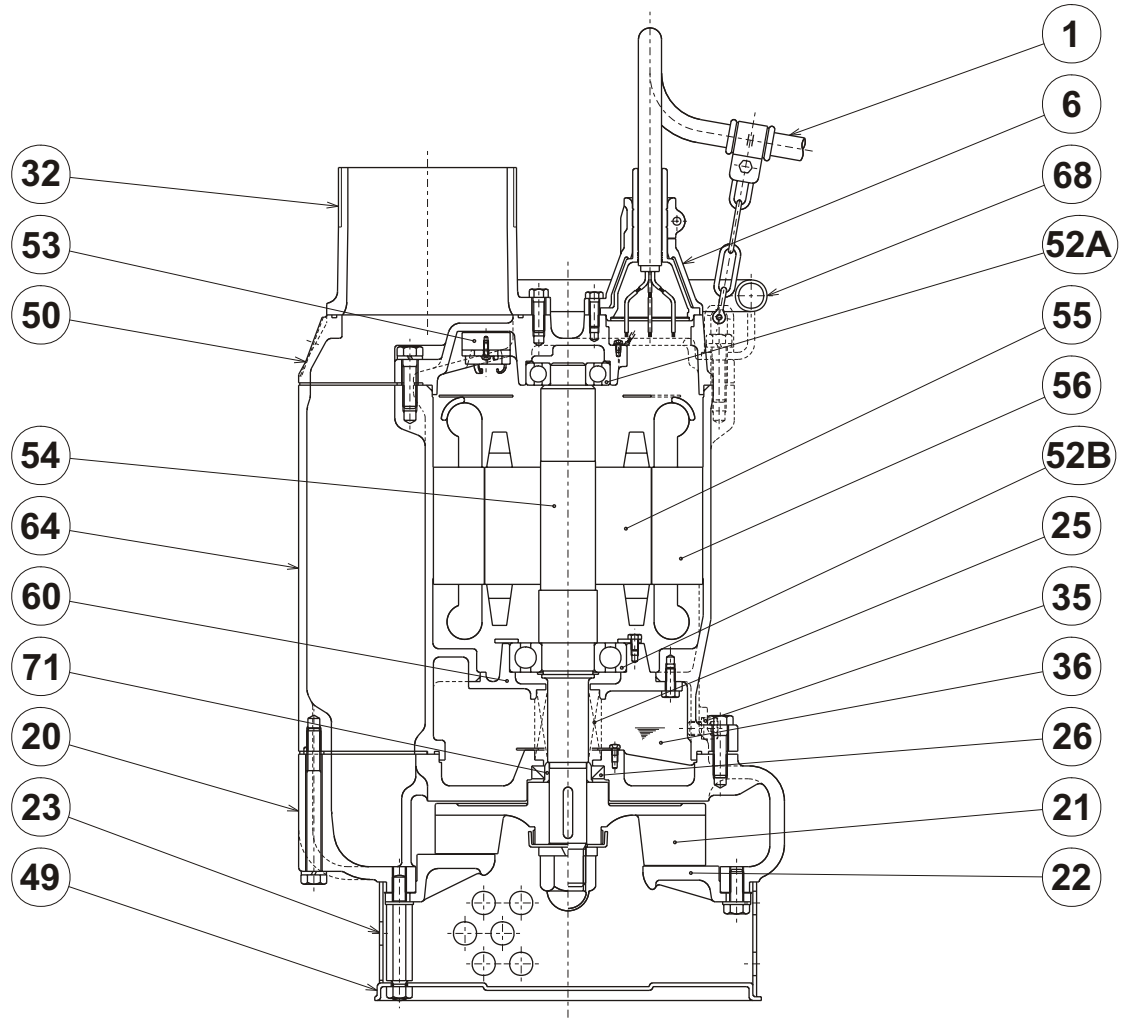

ITEM#	DESCRIPTION	MAIN MATERIAL / NOTE	ASTM, AISI CODE	RELATED DIN CODE	Q'TY
1	Power Cable	Chloroprene Sheath AWG8/4-50ft			1
6	Stuffing Box	Cast Iron	A48 Class 35	1691/GG20	1
20	Pump Casing	Cast Iron	A48 Class 35	1691/GG20	1
21	Impeller	Ductile Cast Iron	A536 Grade 100-70-03	1693/GGG70	1
22	Suction Cover	Cast Iron	A48 Class 35	1691/GG20	1
23	Suction Strainer	Carbon Steel	A109 Class 91	1624-87 St 2,3,4	1
25	Mechanical Seal	Silicon Carbide / H-35			1
	Oil Lifter	ABS Resin			1
26	Oil Seal	Nitrile Butadiene Rubber / DD-406211			1
32	Discharge Connection	Cast Iron / NPT 6"	A48 Class 35	1691/GG20	1
35	Oil Plug	Stainless Steel	AISI 304	17440 X5 CrNi 18-9	1
36	Lubricant	Turbine Oil ISO VG32 or SAE10W/20W			
49	Bottom Plate	Carbon Steel	A109 Class 91	1624-87 St 2,3,4	1
50	Motor Head Cover	Cast Iron	A48 Class 30	1691/GG15	1
52A	Upper Bearing	#6307ZZC3			1
52B	Lower Bearing	#6310ZZC3			1
53	Motor Protector				1
54	Shaft	Stainless Steel	AISI 420	17440 X20 Cr 13	1
55	Rotor				1
56	Stator				1
60	Bearing Housing	Cast Iron	A48 Class 30	1691/GG15	1
64	Motor Housing	Cast Iron	A48 Class 30	1691/GG15	1
68	Handle	Carbon Steel Pipe + Steel	A53 Type F + A283 Grade D	1615/St33 + 17100 RSt 46-2	1
71	Shaft Sleeve	Stainless Steel	AISI 403	17440 X15 Cr 13	1