

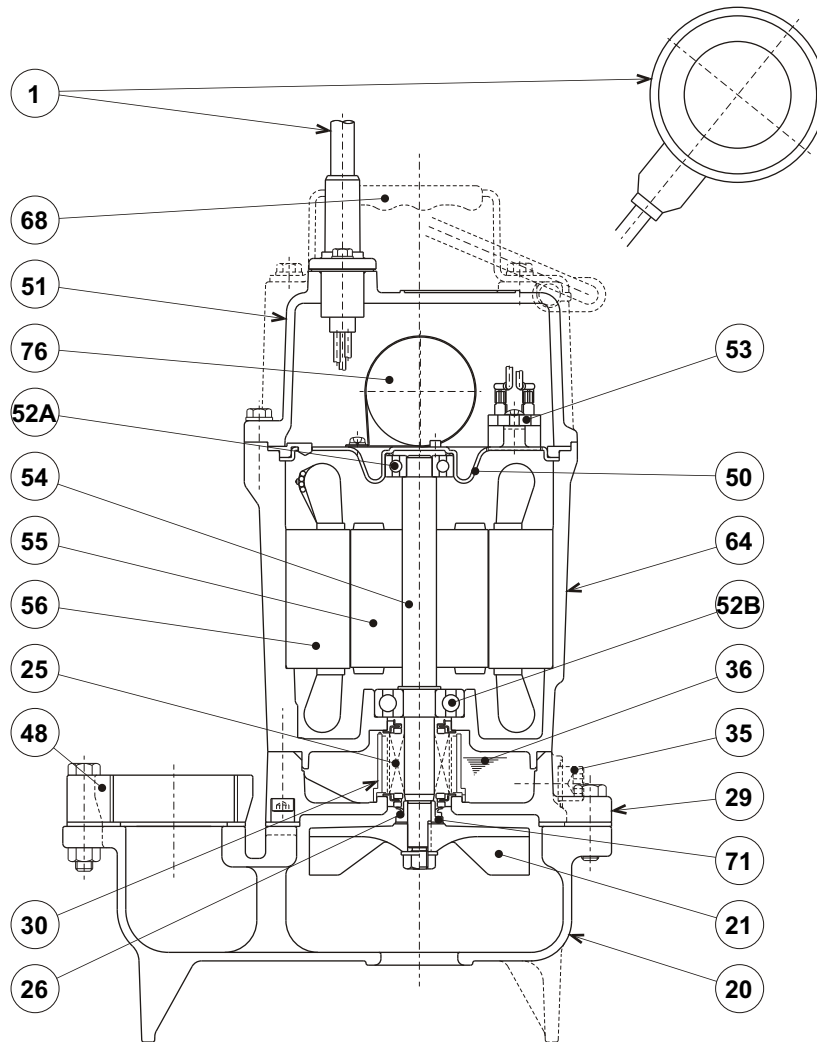

**UT - SERIES**  
**SUBMERSIBLE SEMI - VORTEX - SEWAGE PUMPS**

**SECTIONAL VIEW**

50UTZ2.75S-61



ITEM#	DESCRIPTION	MAIN MATERIAL / NOTE	RELATED ASTM, AISI CODE	RELATED EN CODE	Q'TY
1	Power Cable w/ Float Set	PVC Sheath AWG14/3-32ft w/ PP Resin + Chloroprene Sheath Cable			1
20	Pump Casing	Cast Iron	A48M Class30B	EN 1561 GJL-200	1
21	Impeller	PPO Resin w/GF20			1
25	Mechanical Seal	Silicon Carbide / W-14VL			1
26	V-Ring	Nitrile Butadiene Rubber			1
29	Oil Casing	Cast Iron	A48M Class30B	EN 1561 GJL-200	1
30	Oil Lifter	PBT Resin			1
35	Oil Plug	Stainless Steel	S 30400	1.4301	1
36	Lubricant	Turbine Oil ISO VG32 or SAE10W-20			
48	Companion Flange	Cast Iron / NPT 2"	A48M Class30B	EN 1561 GJL-200	1
50	Motor Bracket	Steel (Electro-Galvanized)	A591	EN 10152	1
51	Motor Head Cover	Cast Iron	A48M Class30B	EN 1561 GJL-200	1
52A	Upper Bearing	#6201ZZC3			1
52B	Lower Bearing	#6302ZZC3			1
53	Motor Protector				1
54	Shaft	Stainless Steel	S 40300	1.4000	1
55	Rotor				1
56	Stator				1
64	Motor Housing	Cast Iron	A48M Class30B	EN 1561 GJL-200	1
68	Handle	Steel (Hot Rolled) + NR Rubber	A1011	EN 10111	1
71	Shaft Sleeve	Stainless Steel	S 30400	1.4301	1
76	Capacitor				1