

100AB2.4S-62
100AB2.4-61
100AB2.75-61

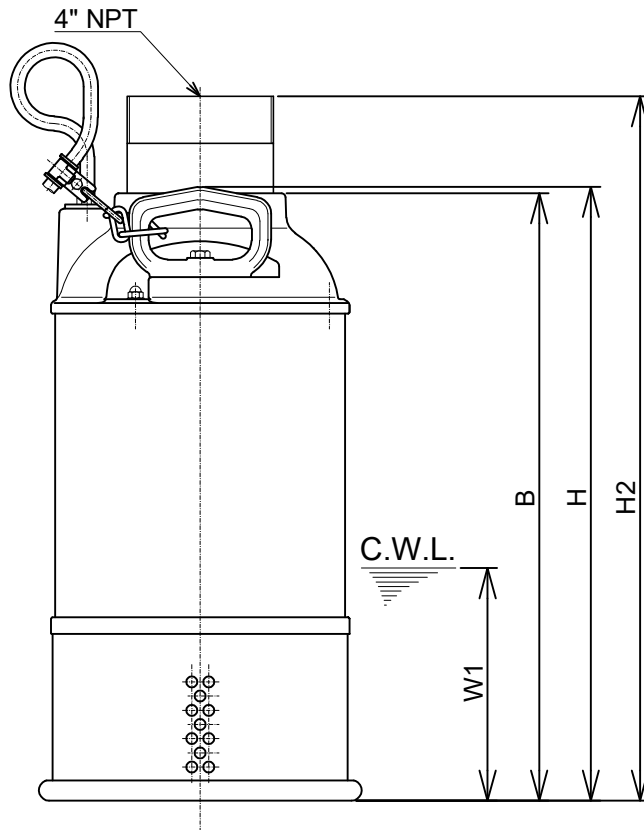

C.W.L. : Continuous running Water Level

DIMENSIONS:USCS (Inch)

Model	HP	NOM. SIZE	Pump & Motor				C.W.L.		*Wt. (lbs.)
			D	B	H	H2	W1		
100AB2.4S-62	1/2	4"	9 13/16	18 4/8	18 11/16	21 7/16	7 1/8	40	
100AB2.4-61	1/2	4"	9 13/16	18 4/8	18 11/16	21 7/16	7 1/8	40	
100AB2.75-61	1	4"	9 13/16	18 4/8	18 11/16	21 7/16	7 1/8	42	

DIMENSIONS:METRIC (mm)

*Excluding Cable

Model	kW	NOM. SIZE	Pump & Motor				C.W.L.		*Wt. (kg)
			D	B	H	H2	W1		
100AB2.4S-62	0.4	100	250	470	475	545	180	18	
100AB2.4-61	0.4	100	250	470	475	545	180	18	
100AB2.75-61	0.75	100	250	470	475	545	180	19	